

REV.	DESCRIPTION	DESIGN	APPROVAL	DATE
A	NEW	Hongmei	BG YANG	2015.12.08

Technical requirement 技术参数：

1. Electrical Characteristics Test 电气性能检验

- 1.1 Products 100% for electrical test, 成品100%电性测试.
- 1.2 Insulation resistance: No less than 100MΩ of 500V DC/0.4S;
绝缘阻抗: 大于或等于100MΩ 500V DC/0.4S;
- 1.3 Dielectric strength 耐电压

- 1.3.1 Between two conductors 2500^{+200}_0 V AC for 1.0s Trip-current 1.0mA max.
导体与导体之间 2500^{+200}_0 V AC /1秒, 漏电流1.0mA(max).
- 1.3.2 Between conductor and body 6000^{+200}_0 V AC for 3.0s - Trip current 1.0mA max.
导体与本体之间 6000^{+200}_0 V AC /3.0秒, 漏电流1.0mA(max).

2. Mechanical Characteristics Test 机械性能检验

- 2.1. Withdrawal force 拔出力
- 2.1.1 For checking each PIN independently from the standard-gauge below 2.0N(Min) Keep for 3S or more.
标准量规对连接器插孔单PIN保持力为最小2.0N保持3秒以上.
- 2.1.2 For checking Integral withdrawal force 60N(Max) from maximum standard gauge. 标准量规(最大值)检查整体拔出力 60N(最大).

3. Finished product conditions 成品状态

- 3.1 The attachment plug front show the test mark of "T".
插头主视面须有测试标志"T".
- 3.2 The dimension with "▽" must be control and inspected importantly.
带"▽"尺寸需重点管控和检验.
- 3.3 material and product comply with Doc No."QW-Q-043" 《material-and product- of restricted substance control specification》.
物料及成品必须符合QW-Q-043 《材料与成品限用物质管理规范》

4. Standards 标准

- 4.1 The cord shall comply with IEC 60227. 线材符合IEC 60227
- 4.2 The molded plug shall comply with BS 1363-1:1995 and SS145/A. 插头符合BS 1363-1:1995和SS 145/A.
- 4.3 The connector shall comply with GB17465.1, 连接器须符合GB17465.1;

wiring method 接线方式：

J1	cord	J2
E	Yellow/Green	E
L	Brown	L
N	Blue	N

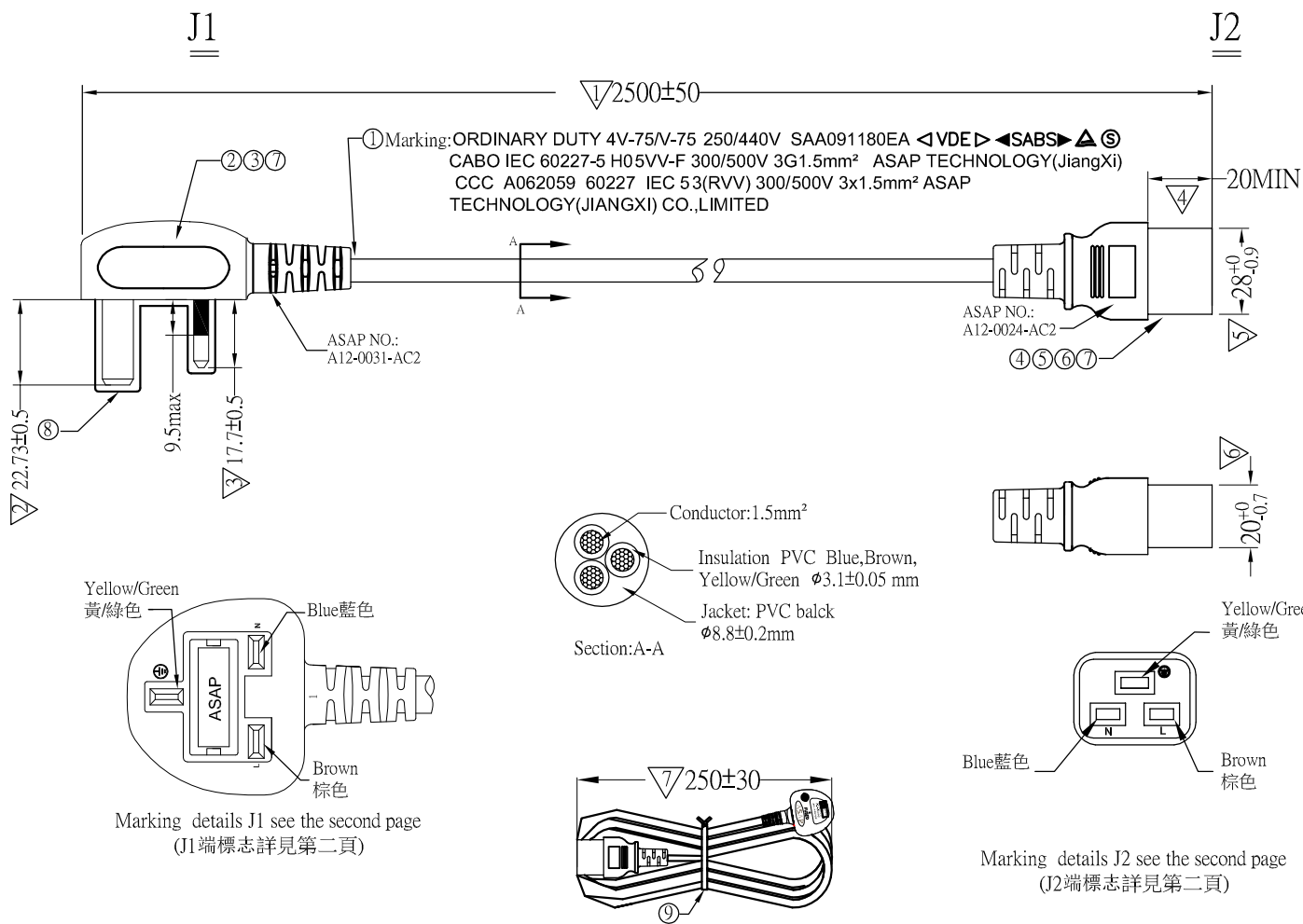

⑨	TIE	Black PE tie meeting RoHS.	pcs	1
⑧	COVER	UK plug protecting cover, white PE, meeting RoHS.	pcs	1
⑦	PLASITC	55P black PVC pellets meeting RoHS and UL94 V-0.	g	NA
⑥	TERMINAL	2X5U type contact terminal with wing for C19 connector,	pcs	3
⑤	HOUSING	Down cover of C19, PBT material, black	pcs	1
④	HOUSING	Upper cover of C19, PBT material, black	pcs	1
③	FUSE	13A fuse ,comply with BS 1362;	pcs	1
②	INSERT	UK fuse plug insert with grounding, nickel-plated, black	pcs	1
①	POWER CORD	H05VV-F 3G1.5mm ² , Φ8.8±0.2mm, Black.	mm	NA
NO.	NAME	MATERIAL DESCRIPTION	UNIT	Q'TY

X.±	X.*±	UNITS	P/N:42 0565
.X±	.X*±	mm	
.XX±	.XX*±	MATL	
.XXX±	.XXX*±	FINISH	PART NO: L8CAC059-QT-N TITLE: UK 3P To C19 L=2.5m Black
THESE DRAWINGS AND SPECIFICATIONS ARE THE PROPERTY OF Luxshare-ICT AND SHALL NOT BE REPRODUCED, COPIED OR CUED IN ANY MANNER WITHOUT THE PRIOR WRITTEN CONSENT OF Luxshare-ICT			
Q'TY			APPD: Baogen Yang
			CHKD: Guangren Ouyang
			DR: Hongmei Hu

SCALE	SHEET	REV.
NONE	1/2	A

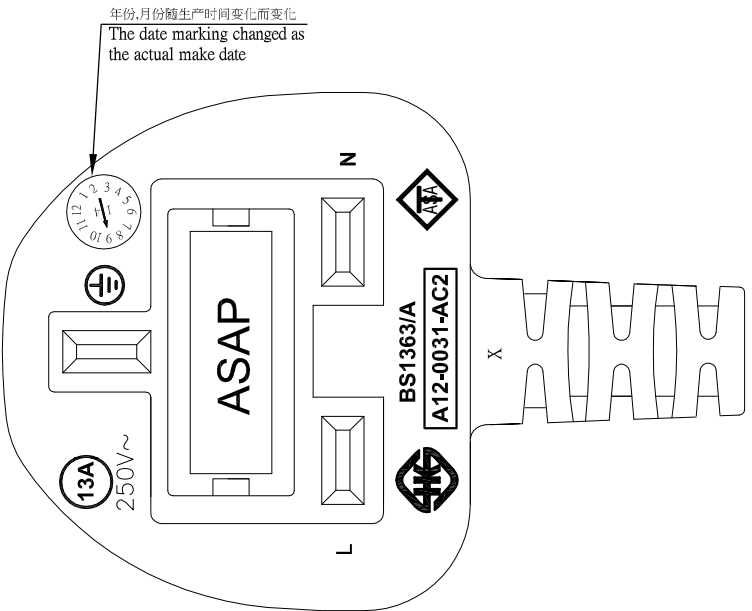
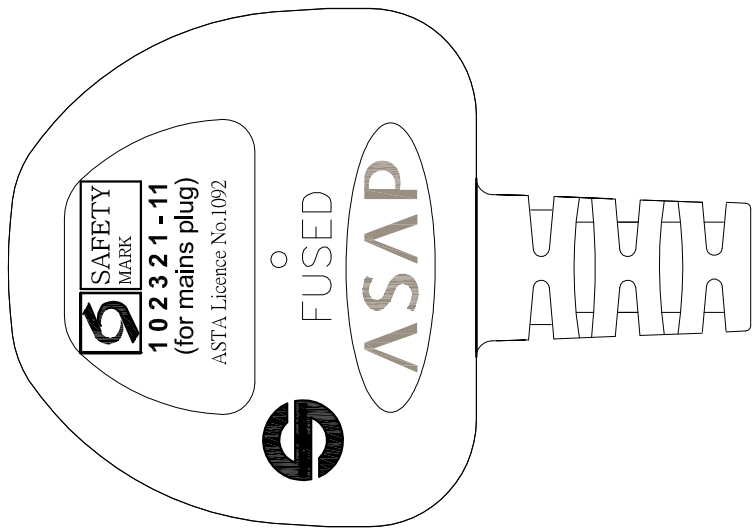

J1 Marking
J1端標誌

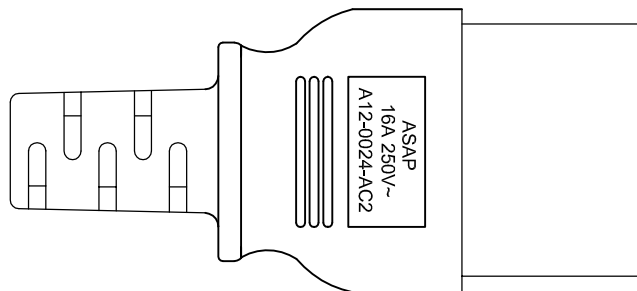
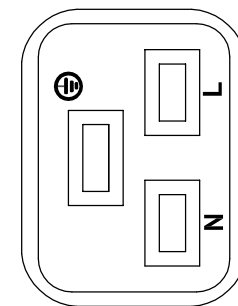
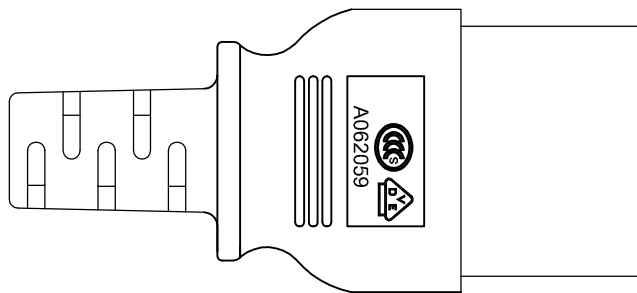

J2Marking
J2端標誌

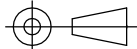
X.±	X.*±	UNITS mm	P/N:42 0565								
.X±	.X*±										
.XX±	.XX*±	MATL	PART NO: L8CAC059-QT-N	TITLE: UK 3P To C19 L=2.5m Black							
.XXX±	.XXX*±		APPD: Baogen Yang	DWG NO: L8CAC059-QT-N							
THESE DRAWINGS AND SPECIFICATIONS ARE THE PROPERTY OF Luxshare-ICT AND SHALL NOT BE REPRODUCED, COPIED OR CUED IN ANY MANNER WITHOUT THE PRIOR WRITTEN CONSENT OF Luxshare-ICT		FINISH	CHKD: Guangren Ouyang	 <table border="1"> <tr> <td>SCALE</td> <td>SHEET</td> <td>REV.</td> </tr> <tr> <td>NONE</td> <td>2/2</td> <td>A</td> </tr> </table>		SCALE	SHEET	REV.	NONE	2/2	A
		SCALE	SHEET			REV.					
		NONE	2/2	A							
Q'TY	DR: Hongmei Hu										